



The ultimate in clean power

A Group brand |  legrand

# NUMERIC<sup>®</sup>

## Digital HPE Series

**Net Ready High Performance Parallel Redundant  
On-Line Double Conversion UPS Systems**

### Features

- Advanced DSP / Microprocessor Controlled
  - SPWM Technology with IGBT's
    - Wide Input Voltage Range
- Intelligent Battery Management System (Optional)
  - True Galvanic isolation design
    - High Efficiency
  - Compact Design to suit the interiors
- Modular Design for Easy Maintenance
  - High MTBF and minimum MTTR
    - SNMP Interface
    - Web enabled monitoring
- Parallel Redundant Configuration (N+1)
- Full Function LCD Display to Monitor Electrical Parameters
  - Compliance to International standards



**NUMERIC - No .1 UPS Manufacturer in India\***

(\*Source: Softdisk)



## Numeric Digital HP E Series

Numeric, the No.1 On-Line UPS Manufacturing Company in India\* with over 25 years of experience in the design and manufacture of UPS systems, offers state-of-art DSP Controller based NUMERIC Digital HP E Series UPS systems. Today, all business applications are based on Technology solutions and sophisticated hardware. The need for Power protection systems providing impeccable power quality with high reliability and availability becomes extremely vital. This is especially for critical enterprise networking applications, Internet servers, VSAT Communication Networks & Switching equipment, Networks, Process Control, Telecommunication, Life Saving Medical applications and such other application where system availability cannot be compromised. The Digital HP E Series UPS systems effectively address these applications with unmatched reliability, power quality, availability and electrical efficiency.

\*Source: Softdisk



### On-Line Double Conversion with Advanced DSP / Microprocessor Technology

Most of the malfunctions in electronic equipment and sophisticated circuits are directly attributed to power aberrations like voltage fluctuations, sags, surges, spikes, transients, RFI, frequency variations, interruptions, brown outs, black outs etc. The continuous double conversion process employed in Numeric Digital HP E series corrects the effect of such electrical aberrations in the input, thereby providing continuous and fail safe protection to the installations that are critical to the business. By means of innovative software control programs, the complicated hardware circuitry, inlaid in powerful DSP / Microprocessor in the Digital HP E Series facilitates high reliability of the system.

High frequency SPWW is the enabling technology, for high power quality and efficient UPS design requirement for critical enterprise

applications. The Digital HP E Series UPS system integrates a DSP / Microprocessor to manage the vital controls in the UPS system. Since the feedback and control loops are implemented digitally, compensation for component tolerances and temperature variations of feedback elements is no longer necessary. Hence, the UPS systems provide greater immunity to noise, and there by increasing the overall reliability.

The DSP / Microprocessor in the Digital HP E Series simultaneously controls multiple power converters to optimize system efficiency and performance characteristics, including advanced battery management for extended battery life, improved output voltage regulation, enhanced bypass capability and communication with networks and other equipment. The Digital HP E Series is smaller, lighter and more reliable.

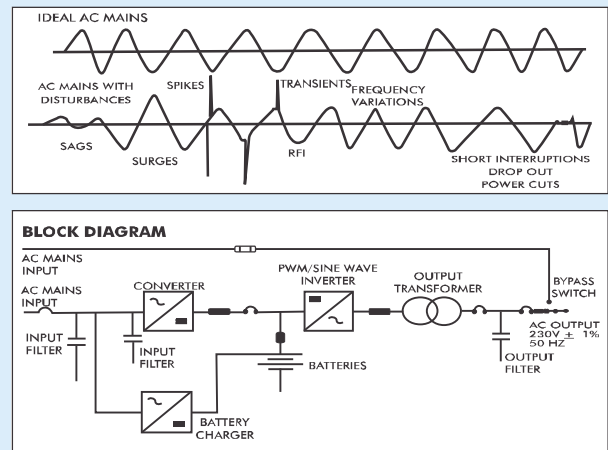

### Low Losses - High Efficiency

The Microprocessor Controlled High Frequency SPWM Technology with IGBTs (voltage controlled devices with high input impedance & consequent low drive requirements) in the NUMERIC Digital HP E Series, ensures Lower Switching Losses, Higher Efficiency (> 90%) resulting in considerable savings in the running cost of the equipment by reducing the energy bills.



### User-Friendly LCD Display

The front panel, displays a set of informative LED Indicators along with a Mimic display for parameters such as Mains ON, Inverter ON / OFF / Faulty, Battery level, Static bypass ON, alarms for Low Battery and Mains Failure.

Full Function LCD Display is available to monitor Rectifier Data - Input Voltage, DC Voltage, Inverter Data - Output Voltage, Output Frequency & Load in Percentage, Bypass Voltage, Frequency, Battery Data - Charging Current & Discharging Current. Touch key Control Switches for Power OFF and Power ON make the operation highly user friendly.

### Comprehensive Protection - Galvanic Isolation

In addition to the total protection offered by the On-Line Double Conversion design employed in the Digital HP E Series UPS System, additional protection is available in the form of Galvanic Isolation between Input & Output. The Static Bypass Switch available in the UPS System enables transfer of load to the Bypass AC input without interruption in the event of any contingencies. NUMERIC also offers bypass line conditioners such as Isolation Transformers and Servo stabilizers to enhance availability of the UPS System.

### Parallel Redundant Configuration

Numeric Digital HP E Series are designed with "N+1" modules, allowing redundancy for high availability and power extension for increase in loads. In a typical parallel redundant configuration individual UPS systems of equal capacities are paralleled together to several larger load that could be served individually.

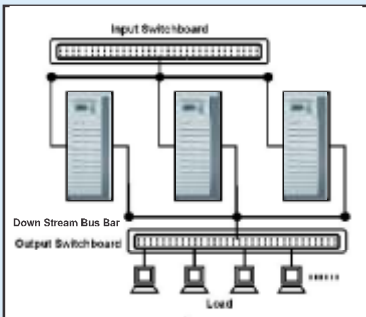

### Compact Design

The advanced technology of NUMERIC Digital HP E Series UPS systems makes it very compact in design. The Digital HP E Series occupies minimum footprint and thereby saving considerable floor space.



### Communication & Remote Monitoring



NUMERIC Digital HP E Series offers a variety of communication solutions and accessories for remote control and supervision of UPS. The standard feature of RS232/RS485 port and software enables the users to supervise the UPS while working on platforms such as Windows XP/Vista/Windows NT/LINUX. The SNMP Communication option facilitates remote / web enabled monitoring of the critical parameters of the UPS system in computer networks with TCP/IP address.

### Highest Uptime - Better Availability

Customer delight has always been the catalyst in the success of NUMERIC and the highest uptime is guaranteed by the nation-wide presence of NUMERIC's 13 Regional offices and 258 service centers supported by over 1000 dedicated sales & support team. The emphasis lies in building relationships and this is evident from the huge base of over 4,00,000 installations of NUMERIC UPS systems across the country and the high level of gratification expressed by the clientele through continued patronage. A pioneer in the field of power conditioning equipment. NUMERIC is the one stop solution provider for all your power conditioning needs.

### NUMERIC GLOBAL NETWORK



● NUMERIC GLOBAL INSTALLATION BASE

# Technical Specification

# NUMERIC®

## Digital HPE Series

### Three Phase Input - Single Phase Output

UPS Rating kVA	20 kVA		30 kVA		40 kVA		50 kVA		60 kVA																					
Product Identification Number (PID No.)	DHP E 20 / DHP E 20 P		DHP E 30 / DHP E 30 P		DHP E 40 / DHP E 40 P		DHP E 50 / DHP E 50 P		DHP E 60 / DHP E 60 P																					
<b>Input (Rectifier)</b>																														
Rectifier input Voltage Range	400 V AC 3 Phase - 25 + 20%																													
Frequency Range	45 - 55 Hz																													
Phase	Three Phase + Neutral + Earth (5Wires)																													
Power Factor	≥ 0.95																													
<b>Output (Inverter)</b>																														
Voltage	220 / 230 V AC																													
Voltage Regulation	+/- 1%																													
Frequency	Automatic synchronised tracking on utility power mode; 47 - 53 Hz, +/- 1% on battery mode																													
Output Waveform	Sinewave																													
Harmonic Distortion (THD)	≤ 2% (Liner Load) / ≤ 5% (Non - Liner Load)																													
Voltage Transient (Dynamic Response)	For 0-100% & 100-0% step load change the output shall remain within ± 5% & recovers to normal within 20 m sec.																													
Power Factor	0.8 lag																													
Crest Factor	3:1																													
Efficiency (AC-AC)	≥ 90%																													
Inverter Overload Capacity	125% for 10 Minutes; 150% for 20 seconds																													
<b>Battery</b>																														
Battery Type	Sealed Maintenance Free Lead Acid, Lead Acid Tubular, Ni-cd (Battery Voltage, Ah and Quantity depending on Backup Time)																													
DC Voltage	360 V																													
Charger	Constant Voltage Constant Current Charger																													
Charger (Optional*)	Intelligent MMBM Battery Management system using Multi - Mode charging to enhance reliability and usage life of batteries																													
Bypass	Static Bypass / Manual Maintenance Bypass																													
<b>Communication Interface</b>																														
Standard	RS 232 port for software interface																													
Optional (SNMP)	SNMP network adapter interface for network management of power supply																													
Optional (Remote Control - RS 485)	Independent Digital Remote Control at a distant of 1000 mts. Supported by RS 485 for safe and convenient remote control																													
<b>General</b>																														
Operating Temperature	0 Deg. to 40 Deg. C																													
Relative Humidity	0-95% RH, Non Condensing																													
Noise Level	< 60 dB @ 1 Meter																													
Indication	Mains ON / Faulty / Inverter ON / Faulty / Bypass Mode / Battery Low / No Load / System Fault																													
<b>Display</b>																														
LCD Display	LCD Display to monitor input voltage, Battery Voltage, Charging Current, Discharge Current Output Voltage, Output frequency, Load Percentage, Bypass voltage & Frequency																													
Audible Alarm	Mains Failure Alarm, Low Battery Alarm, Overload and over Temperature																													
Protection Standards	Low Battery protection, overload protection, Short circuit protection, output over voltage protection																													
Parallel Function	EN 50091-1 for Safety / EN 50091-2 for EMC Available																													
<b>Dimensions</b>																														
	H	X	W	X	D	Wt.	H	X	W	X	D	Wt.	H	X	W	X	D	Wt.	H	X	W	X	D	Wt.	H	X	W	X	D	Wt.
Dimensions (mm) and Weight (kgs)	1180	X	400	X	800	220	1180	X	400	X	800	240	1180	X	400	X	800	260	1180	X	400	X	800	280	1180	X	500	X	800	300

As standards, specifications and design change from time to time, please ask for confirmation of the information given in this publication.

\*For custom - built specifications please contact us.

NUMERIC HOUSE No.5 , Sir P.S.Sivasamy Salai, Mylapore, Chennai - 600 004, INDIA .

Tel : +91 -44-2499 3266 Fax : +91 -44-24998210 E-mail : info@numericups.com



A Group brand | **Legrand**

**REGIONAL OFFICE: AHMEDABAD** 079 - 27488779 / 556 **BANGALORE** 080 - 43038000, 01 / 02 / 03 / 04 **BHOPAL** 0755 - 2764201, 2764202 **CHENNAI** 044 - 24982502, 24982511, 24990466, 24990064, 24993266 **COCHIN** 0484 - 2324616, 2322334 **COIMBATORE** 0422 - 2242290, 2243716, 2243740 **HYDERABAD** 040-27603048, 27662817 **KOLKATA** 033-24609233, 24609234, 24609032 **LUCKNOW** 0522 - 2206110, 2206112 **MADURAI** 0452-2604555, 2602629 **MUMBAI** 022-28373953/54/55 **NEW DELHI** 011-25571347/48/49



Toll Free No. 1800 425 3266  
www.numericups.com  
NPDM/MKT/BRO/1PH/03

NUMERIC 1/2013

Please Refer our website : [www.numericups.com](http://www.numericups.com) for list of our service centers.

NOVATEUR ELECTRICAL & DIGITAL SYSTEMS PRIVATE LIMITED



The ultimate in clean power

A Group brand |  **legrand**

# NUMERIC<sup>®</sup>

## Digital HPL Series

### Double Conversion On-Line UPS Systems

#### Features

- Small Foot Print
- Microprocessor Based Design
- True On-Line Double Conversion
- High Frequency SPWM Design
  - IGBT Inverter
- Inbuilt Galvanic Isolation Transformer
- Protection From Spikes, RFI, EMI etc..
  - Constant Voltage & Frequency
  - High Efficiency
  - Proven Performance
- Extended Battery Backup
  - RS232 Com. Port
- SNMP Interface (Optional)
- Wide Input Voltage Range
- Programmable Power Walk-in
- Manual / Static Bypass Switches
  - Coldstart Compatability
- Reliability, Safety & Security



(\*Source: Softdisk)

NUMERIC - No. 1 UPS Manufacturer in India\*



## NUMERIC - Powerful Solutions

Numeric, the undisputed leader in UPS Systems in India\* brings to you the wide range of IGBT based Double conversion On-line UPS Systems. Compact, elegant & reliable, incorporating the state-of-the-art design and enabling an augmentation in productivity, NUMERIC UPS Systems protect your sensitive equipment from perils such as spikes, surges, voltage fluctuations, black outs and other aberrations.

(\*Ranked as the No.1 On-Line UPS manufacturer in India source : Softdisk)

## NUMERIC - Invincible Range

Technology advances in power electronics started from improvements in semiconductor power devices, with insulated gate bipolar transistors (IGBTs). IGBTs feature many desirable properties including a MOS input gate, high switching speed, low conduction voltage drop, high current carrying capability and a high degree of robustness. In fact easy control, excellent switching characteristics and high reliability make IGBTs the best choice for UPS systems. IGBTs significantly improve UPS performance, particularly in terms of efficiency, acoustic noise, size and weight



## NUMERIC - Unmatched Quality

Quality is a priority at Numeric. The UPS systems manufactured by Numeric carries the ISO : 9001 certification, awarded by BVQi. The products undergo stringent quality tests directed at providing the customers with only the best. The systems are regularly inspected, evaluated and certified by the DOT, DOE, MECON RDSO, DGS & D and other leading test houses like SAMEER, ETDC and endorsed by all leading computer OEMs for optimum uptime and high performance.

## Comprehensive Protection - Galvanic Isolation

In addition to the total protection offered by the On-Line Double conversion design employed in the Digital HPL series UPS System, additional protection is available in the form of Galvanic Isolation between Input & Output.

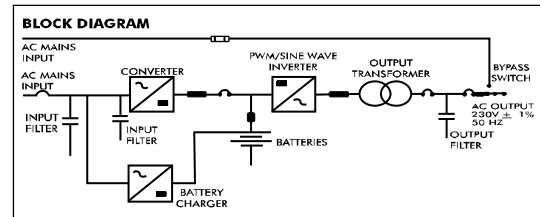
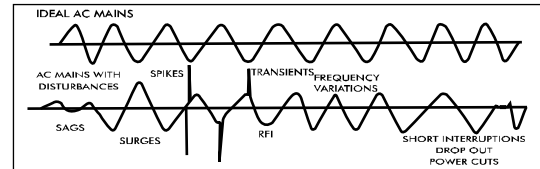

The static bypass switch (optional) available in the UPS Systems enables transfer of load to the bypass AC input without interruption in the event of any contingencies. Numeric also offer bypass line conditioners such as isolation transformers and servo stabilisers to enhance availability of the UPS Systems.

## Communication & Remote Monitoring

Numeric Digital HPL series offers a variety of communication solutions and accessories for remote control and supervision of UPS. The standard feature of RS232 port and software enables the user to supervise the UPS while working on platforms such as XP / Vista / Windows NT / LINUX. The SNMP communication option offers web-enabled monitoring of the critical parameters of the UPS from any part of the world through internet.



## Digital Display (Optional)

Features:

- Digital display of UPS electrical parameters through LCD module with back lit facility
- Full digital calibration
- Real time clock
- RS232 Com. Port for computer Interface



## Technical Specification

# NUMERIC<sup>®</sup>

*Digital HPL Series*

		Capacity		Dimension (mm)			Wt kg
				H	W	D	
<b>Capacity in kVA</b>		<b>1kVA - 60kVA</b>					
<b>Input (Rectifier)</b>		<b>kVA</b>	<b>I / O</b>	<b>H</b>	<b>W</b>	<b>D</b>	
Technology	Switch mode rectifiers / Phase controlled rectifiers						
Primary source voltage	230 VAC 1 Phase / 400 VAC 3Phase (+ / - 15% to 30%)	1.0	1Ph-1Ph	680	300	630	51
Output characteristics	Constant Voltage, Constant Current						
Power device	IGBTs / SCRs	2.0	1Ph-1Ph	680	300	630	56
Protection	Advanced electronic protection for device safety backed up with MCBs / MCCBs and fast acting fuses. Soft start for 0-20 sec, power walk - in	3.0	1Ph-1Ph	680	300	630	65
Input Power Factor	> 0.95 with Harmonic suppression						
<b>Output (Inverter)</b>		5.0	1Ph-1Ph	705	350	725	83
Technology	1kVA - 120kVA: Digital SPWM IGBT Design						
DC Volts	72, 96, 120, 192, 240, 300, 360, 384 VDC	5.0	3Ph-1Ph	840	350	805	145
Output Voltage	230 V AC 1 Phase / 110 V AC 1 Phase* / 400 / 415 V AC 3 Phase						
Output Frequency	50 Hz (+ / -0.1%)	7.5	3Ph-1Ph	840	350	805	160
Output wave form	Sinusoidal						
Switching Frequency	12 - 24 kHz	10	3Ph-1Ph	840	350	805	170
Harmonic Distortion	THD <2% for linear loads, <5% for non - linear loads.						
Transient Response	For 100% step load change, + / - 5% and recovers to normal within 20 milliseconds	15	3Ph-1Ph	1010	500	770	220
Efficiency	85 - 92%						
Crest factor	3:1	20	3Ph-1Ph	1150	500	770	260
Overload	150% for 1 min. 125% for 10min.						
Power Factor	0.6 to Unity	25	3Ph-1Ph	1150	500	770	315
Power Device	IGBTs (Insulated Gate Bipolar Transistors)						
Protection	Advanced electronic protection for device safety backed up with MCBs / MCCBs and fast acting fuses. High speed pulse blanking. Electronic over voltage / Undervoltage protection. Electronic over current trip with reset	30	3Ph-1Ph	1150	500	770	350
		40	3Ph-1Ph	1600	760	660	410
<b>General</b>							
Back-up	DC Source - SMF / Lead Acid Tubular / Ni - Cd						
	Backup time - 10 min. to 8 hours*	50	3Ph-1Ph	1700	900	900	500
Indications	Mains ON, DC ON, Output ON, Converter fault, Low DC, Inverter Trip						
	OP High, OP Low, Bypass Mode, Battery Mode	60	3Ph-1Ph	1700	900	900	620
Metering	Input voltage, DC volts, DC Current (charge / discharge), AC Output Volts						
	AC load current, Output freq.						
Ambient Temperature	Standard: 0 - 45 Deg.C Optional: 0 - 50 Deg.C						
Relative Humidity	0 - 95% RH, Non - Condensing						
Cooling	Forced Air						

\*\*Technical Specification and Dimension of 3Ph - 3 Ph UPS systems/Higher Capacities will be provided on request  
As standards, specifications and design change from time to time, please ask for confirmation of the information given in this publication.

\* For custom-built specifications please contact us.

### Optional Features\*

- 3 Phase input UPS to work in 2 Phase input power supply
- Parallel Redundant / Hot standby modes
- Static bypass switch for automatic load transfer
- Remote Indicator panel with status indications
- Isolation Transformer and servo stabiliser in bypass line
- Output Voltage: 110 Volts AC
- Software support: Windows 98 / 2000 / XP / Vista / NT / LINUX /
- IP options available on request

## Highest Uptime - Better Availability

Customer delight has always been the catalyst in the success of NUMERIC and the highest uptime is guaranteed by the Nation - wide presence of NUMERIC's 12 Regional offices and over 258 service centers supported by over 1000 dedicated sales & support team. The emphasis lies in building relationships and this is evident from the huge base of over 4,00,000 installations of NUMERIC UPS systems across the country and the high level of gratification expressed by the clientele through continued patronage. A pioneer in the field of power conditioning equipment, NUMERIC is the one-stop solution provider for all your power conditioning needs.



NUMERIC HOUSE No.5 , Sir P.S.Sivasamy Salai, Mylapore, Chennai - 600 004, INDIA .

Tel : +91 -44-2499 3266 Fax : +91 -44-24998210 E-mail : info@numericups.com



The ultimate in clean power

A Group brand | **legrand**

**REGIONAL OFFICE: AHMEDABAD** 079 - 27488779 / 556 **BANGALORE** 080 - 43038000, 01 / 02 / 03 / 04 **BHOPAL** 0755 - 2764201, 2764202  
**CHENNAI** 044 - 24982502, 24982511, 24990466, 24990064, 24993266 **COCHIN** 0484 - 2324616, 2322334 **COIMBATORE** 0422 - 2242290, 2243716, 2243740 **HYDERABAD** 040-27603048, 27662817 **KOLKATA** 033 -24609233, 24609234, 24609032 **LUCKNOW** 0522 - 2206110, 2206112 **MADURAI** 0452-2604555, 2602629 **MUMBAI** 022-28373953/54/55 **NEW DELHI** 011-25571347/48/49



ISO 9001 : 2008  
 ISO 14001 : 2004  
 BS OHSAS 18001 : 2007



No.1 Power Electronics Company  
 No.1 On Line UPS Manufacturer  
 No.1 Line Interactive UPS Manufacturer  
 Source - SoftBank



Toll Free No. 1800 425 3266  
 www.numericups.com  
 NPDM/MKT/BRO/1PH/04

Please Refer our website : [www.numericups.com](http://www.numericups.com) for list of our service centers.





The ultimate in clean power

A Group brand |  legrand

# NUMERIC<sup>®</sup>

## Digital HP Max Series

1 kVA - 3 kVA

**Net Ready High Performance  
On-Line Double Conversion UPS Systems**

### FEATURES

- Advanced DSP Controlled UPS System
  - SPWM Technology with IGBT's
  - Wide input voltage range
  - Input THDi < 5%
- True galvanic isolation design(Optional)
  - High efficiency
- Compact design to suit the interiors
- Modular design for easy maintenance
  - High MTBF and minimum MTTR
- SNMP interface - web enabled monitoring
- Full function LCD display to monitor electrical parameters
  - Compliance to International standards



**NUMERIC - No.1 UPS Manufacturer in India\***

(\*Source: Softdisk)



# TECHNICAL SPECIFICATION

# NUMERIC®

# Digital HP Max Series

PARAMETER	1kVA / 800 Watts	2kVA / 1600 Watts	3kVA / 2400 Watts
<b>Input</b>			
Voltage range	Based on load percentage (0~50%:110V / 51~100%:160V) +3%Vac		
Line low transfer	Line Low Loss +110VAC (±3%)		
Line low comeback	300VAC (±3%)		
Line high transfer	290VAC (±3%)		
Line high comeback	45-55Hz / 54-66Hz ( 50/60 Hz Auto sensing )		
Frequency Range	Single Phase with ground		
Phase	0.99 to unity. (I/P:220V,FULL RCD LOAD)		
Power Factor	< 5% with full Load		
THDi			
<b>Output</b>			
Voltage	200VAC*/208VAC*/220 VAC / 230 VAC / 240 VAC		
Voltage Regulation	+ / - 1%		
Frequency	50/60 Hz +/- 0.2Hz		
Synchronization range	45-55Hz / 54-66Hz		
Harmonic Distortion(THDv)	≤ 3% (linear load)		
	≤ 5% for 100% Non - linear load		
Output Waveform	Pure sine wave		
Crest Factor	3:1		
Efficiency (AC - AC)	> 90%		
Power Factor	0.8		
Overload	105% ~ 110%: 10min / 111%~130% : 1 min / 131%~150% : 10 Sec		
<b>Battery</b>			
Battery Type	Sealed Lead Acid Maintenance Free, Lead Acid Tubular (Battery AH and Quantity depending on backup time)		
DC Voltage	36 VDC		
Charger	96 VDC		
	Built-in solid state float-cum-boost charger with automatic boost / trickle charge modes with current limiting features.		
<b>Transfer Time</b>			
Line mode to battery mode	0 ms		
Inverter to bypass, ECO mode	<4ms		
ECO to Inverter mode	<10ms		
<b>Features</b>			
ECO Mode	Yes		
Fan Speed Control	Yes		
EPO Function	Yes		
Frequency Converter Mode (Default)	Yes, Derating to 60% of the capacity		
Frequency Converter Mode (Optional)	Without Derating		
<b>General</b>			
Operating Temperature	0 to 45 Deg. C		
Noise level	<50 dB @ 1 meter		
Display & Indication	User Friendly LCD Display		
	Input : Voltage ,current & frequency      Battery : Voltage / Discharge Current / Level		
	Output : Voltage ,current , frequency and Load Level in %      UPS Status : Operating Mode / Warning / Fault / codes ( faults & warnings )		
	Indication : in LCD      Input : High / Normal / Low / Fail      Battery : Low / High / Charge / Discharge / Disconnected		
	Output : Overload / Shortcircuit / Fault      UPS Setting : Output Voltage / Frequency / Bypass Enable / Disable / special function: ( UPS / CVCF / ECO )		
Audible Alarm	Mains Failure alarm      Low Battery Alarm      Overload, Fault		
Protections	Advanced electronic protection for device safety backed with MCBs and Fast acting fuses, High speed pulse blanking, Electronic overvoltage / undervoltage protection		
Bypass	Static Bypass		
<b>Communication Interface</b>			
Standard	RS 232 port for software interface		
Optional	USB for software interface· SNMP / RS485 / AS400 Card		
<b>Standards</b>			
	IEC 62040-1 Safety / IEC62040-2 EMC		
<b>Dimension(mm) &amp; Weight(kgs)</b>			
Floor Model without Galvanic isolation	220 H x 145 W x 400 D / 7 Kg	347 H x 192 W x 460 D / 13 Kg	347 H x 192 W x 460 D / 14 Kg
Floor Model with Galvanic isolation	505 H x 200 W x 430 D / 23 Kg	655 H x 220 W x 460 D / 39 Kg	655 H x 220 W x 460 D / 44 Kg
Rack Model without Galvanic isolation	133 H x 445 W x 450 D / 7Kg	133 H x 445 W x 450 D / 13Kg	133 H x 445 W x 450 D / 14 Kg
Rack Model with Galvanic isolation	222 H x 445 W x 450 D / 28 Kg	222 H x 445 W x 450 D / 44 Kg	222 H x 445 W x 450 D / 49 Kg

As standards, specifications and design change from time to time, please ask for confirmation of the information given in this publication.  
Rack Mount UPS dimensions available on request.

NUMERIC HOUSE No.5 , Sir P.S.Sivasamy Salai, Mylapore, Chennai - 600 004, INDIA .  
Tel : +91 -44-2499 3266 Fax : +91 -44-24998210 E-mail : info@numericups.com



A Group brand | Legrand

**REGIONAL OFFICE:** AHMEDABAD 079 - 27488779 / 556 BANGALORE 080 - 43038000, 01 / 02 / 03 / 04 BHOPAL 0755 - 2764201, 2764202 CHENNAI 044 - 24982502, 24982511, 24990466, 24990064, 24993266 COCHIN 0484 - 2324616, 2322334 COIMBATORE 0422 - 2242290, 2243716, 2243740 HYDERABAD 040-27603048, 27662817 KOLKATA 033 - 24609233, 24609234, 24609032 LUCKNOW 0522 - 2206110, 2206112 MADURAI 0452-2604555, 2602629 MUMBAI 022-28373953/54/55 NEW DELHI 011-25571347/48/49

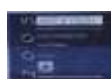

Toll Free No. 1800 425 3266  
www.numericups.com  
NPDM/MKT/BRO/1PH/01

Please Refer our website : [www.numericups.com](http://www.numericups.com) for list of our service centers.

NOVATEUR ELECTRICAL & DIGITAL SYSTEMS PRIVATE LIMITED



The ultimate in clean power

A Group brand | 

# NUMERIC<sup>®</sup>

*Digital HP Max Series*

5kVA - 20kVA

Net Ready on-Line  
Double Conversion, High performance  
UPS Systems with Advanced DSP technology

## FEATURES

- DSP controller based design
- High Power Density- Output PF 0.9
- Active Power Factor Correction
- High Input PF 0.99 to Unity
- Input THDi < 5%
- Utility frequency independent
- pure sine Wave output
- Wide Input Voltage range
- Full time EMI/RFI suppression
- High Efficiency > 93%
- Cold start capability
- Full function LCD Display to monitor electrical parameters
- Smart battery management
- Generator Compatibility
- Galvanic Isolation option
- Compact Design, Small footprint
- User Friendly features
- SNMP Interface - Web enabled monitoring
- Custom built - Long backup Models
- Parallel Redundant configuration
- Compliance to International standards



NUMERIC - No .1 UPS Manufacturer in India\*

(\*Source: Softdisk)



# TECHNICAL SPECIFICATION

# NUMERIC®

# Digital HP Max Series

PARAMETER	5kVA / 4.5kW	6kVA / 5.4kW	7.5kVA / 6.5kW	10kVA / 9kW	7.5kVA / 6.5kW	10kVA / 9kW	15kVA / 13.5kW	20kVA / 18kW
MODEL	DHP Max 5000	DHP Max 6000	DHP Max 7500	DHP Max 10K	DHP Max 31 7K5	DHP Max 31 10K	DHP Max 31 15K	DHP Max 31 20K
<b>Input</b>								
Phase	Single Phase with Ground (L-N-G)				Three Phase with Ground (R-Y-B-N-G)			
Voltage Range	110 VAC - 276 VAC (Based on Load percentage) (0~50% : 110 V / 51~100% : 176 V) ± 3% Vac				190 VAC - 478 VAC (Based on Load percentage) (0~50% : 190 V / 51~100% : 305 V) ± 3% Vac			
Line low transfer	Line Low Transfer +15~20VAC (±3%)				Line Low Transfer +25~35VAC (±3%)			
Line low comeback	276 VAC (±3%)				478 VAC (±3%)			
Line high transfer	266 VAC (±3%)				461 VAC (±3%)			
Line high comeback	45-55 Hz / 55-65 Hz (50/60 Hz Auto sensing)							
Frequency Range	0.99 to Unity (I/P:230 V, FULL RCD LOAD) / 0.95 (above 25% Load)							
Power Factor	< 5% with full Load (1)							
THDi								
<b>Bypass</b>								
Voltage Range	176 ~ 264 V (Default) can be adjustable 176 ~ 276 AC							
Line low comeback	Line Low Loss + 10 VAC							
Line high comeback	Line Low Loss - 10 VAC							
Frequency Range	45 - 55 Hz / 55 - 65 Hz							
<b>Output</b>								
Voltage	208 VAC <sup>(2)</sup> / 220 VAC / 230 VAC / 240 VAC				200 VAC <sup>(2)</sup> / 208 VAC <sup>(2)</sup> / 220 VAC / 230 VAC / 240 VAC			
Voltage Regulation	+ / - 1%							
Frequency	50/60 Hz +/- 0.1 Hz (Free Running Mode)							
Synchronization range	45 - 55 Hz / 54 - 66 Hz <sup>(3)</sup>				46 - 54 Hz / 54 - 66 Hz <sup>(3)</sup>			
Harmonic Distortion(THDv)	≤ 2% (linear load) ≤ 5% (non-linear load)				< 2% (linear load) < 5% (non-linear load)			
Output Waveform	Pure sine wave							
Crest Factor	3:1							
Efficiency (AC - AC)	92% @ Full R Load (without isolation)				93% @ Full R Load (without isolation)			
Power Factor	0.9							
Overload	105%~125%: 10min/ 126%~150%: 1min/ >150%: 10Sec/ >170%: 1Sec				101%~109%: 5min / 110%~129%: 1min/ 130%~150%: 10Sec/ >150%: 2Sec			
<b>Battery</b>								
Battery Type	Sealed Lead Acid Maintenance Free, Lead Acid Tubular (Battery AH and Quantity depending on backup time)							
DC Voltage	240 VDC				288 VDC			
Charger	Built-in solid state three stage charger ( constant current ,Constant voltage with float charge ) and with Temperature Compensation.							
<b>Transfer Time</b>								
Line mode to battery mode					0 ms			
Inverter to bypass, ECO mode					0 ms			
Bypass to Inverter					0 ms			
ECO to Inverter mode					< 10ms When Bypass voltage or frequency is out of range			
<b>Features</b>								
ECO Mode					Yes			
Fan Speed Control					Yes			
EPO Function					Yes			
Frequency Converter Mode (Default)	Yes ( derated to 60 % when the input source is 1phase ) & Bypass output is Disabled							
Parallel function (Optional)	Up to 4 units							
<b>General</b>								
Operating Temperature	0 to 45°C							
Noise level	<55 dB @ 1 meter							
Display & Indication	User Friendly Dot matrix LCD Display							
	Input : Voltage & frequency Battery : Voltage & Level in % Internal DC Bus voltage & Internal temperature							
	Output : Voltage , frequency, current, power and Load Level in % UPS Status : Operating Mode / Warning / Fault / codes ( faults & warnings )							
	UPS Setting : Output Voltage / Frequency/ Bypass Enable/ Disable/							
	Special function: ( UPS/ CVCF/ ECO) Status LED, Normal Mode/ Load on Bypass/ System Fault							
Audible Alarm	Mains Failure alarm/ Low Battery alarm, UPS Warning, Overload, Fault & Bypass mode etc.							
Protections	Advanced electronic protection for device safety backed with MCBs fast acting fuses, High speed pulse blanking Electronic overvoltage/ undervoltage							
Connection	Terminal Block for input/ Battery & output <sup>(4)</sup>				Terminal Block for input/ Bypass/ Battery & output			
Bypass					Static Bypass			
Maintenance Bypass Switch					Available			
<b>Communication Interface</b>								
Standard	RS 232/ USB port for software interface ( any one can be used at a time)							
Intelligent slot	For SNMP (Optional)/ For AS400 (Optional)							
<b>Dimension(mm) &amp; Weight(kgs)</b>								
Floor Model with Galvanic isolation	800 H x 320 W x 660 D 53 kg	800 H x 320 W x 660 D 58 kg	825 H x 320 W x 700 D 60 kg	825 H x 320 W x 700 D 70 kg	910 H x 350 W x 680 D 120 kg	910 H x 350 W x 680 D 140 kg	1180 H x 350 W x 650 D 165 kg	1180 H x 350 W x 650 D 175 kg

\*Rack mount with Galvanic isolation Dimension available on request  
\*Rack mount without Galvanic isolation Dimension available on request

(1) : Source vTHD must be <2% (with nominal input voltage 230 V) (2) : Derate to 90% with 200 & 208 Vac output voltage

(3) : Output Frequency is synchronised with Bypass source. If Bypass source is failure the output frequency of UPS will go to free-run mode (4) : Bypass Source is internally looped with Input. Separate terminal can be provided as optional.

Product specifications are subject to change without prior notice

NUMERIC HOUSE No.5 , Sir P.S.Sivasamy Salai, Mylapore, Chennai - 600 004, INDIA .

Tel : +91 -44-2499 3266 Fax : +91 -44-24998210 E-mail : info@numericups.com



A Group brand | Legrand

**REGIONAL OFFICE: AHMEDABAD** 079 - 27488779 / 556 **BANGALORE** 080 - 43038000, 01 / 02 / 03 / 04 **BHOPAL** 0755 - 2764201, 2764202 **CHENNAI** 044 - 24982502, 24982511, 24990466, 24990664, 24993266 **COCHIN** 0484 - 2324616, 2322334 **COIMBATORE** 0422 - 2242290, 2243716, 2243740 **HYDERABAD** 040-27603048, 27662817 **KOLKATA** 033 - 24609233, 24609234, 24609032 **LUCKNOW** 0522 - 2206110, 2206112 **MADURAI** 0452-2604555, 2602629 **MUMBAI** 022-28373953/54/55 **NEW DELHI** 011-25571347/48/49



Toll Free No. 1800 425 3266  
www.numericups.com  
NPDM/MKT/BRO/1PH/02

Please Refer our website : [www.numericups.com](http://www.numericups.com) for list of our service centers.

NOVATEUR ELECTRICAL & DIGITAL SYSTEMS PRIVATE LIMITED



The ultimate in clean power

A Group brand | 

# NUMERIC<sup>®</sup>

## HD FS 33 Series

High Performance Modular UPS System

10 kVA to 100 kVA



## FEATURES

- True On-Line Double Conversion UPS
- Low Input THDi: 4% - 5%
- High Input Power Factor: >0.99
- Hybrid High Efficiency Inverter design
- Very High Efficiency: 96%
- Cost Effective Modular Design
- N+1 Redundancy
- Low MTTR

**NUMERIC - No. 1 UPS Manufacturer in India\***

(\*Source: Softdisk)



**HP FS 33** is a state-of-the-art modular UPS system with *true On-Line* topology. The HP FS 33 modular design makes scalability simple: High power density provides the benefits of a small footprint and low heat dissipation. The HP FS 33 has rich management and communication capabilities that includes remote monitoring & control through the Internet. Its hybrid static switch ensures high reliability and compliance with IEC standards.



### The UPS That Grows With Your Business

As your power requirements go up you can insert up to a total of ten 10 kVA hot-swap plug-in modules, each weighing only 9kg. The HP FS 33 can be configured in parallel for N+1 or N+ 2 redundancies.



### True On-Line UPS

#### Double Conversion True On-Line UPS (VFI)

According to IEC 62040-3

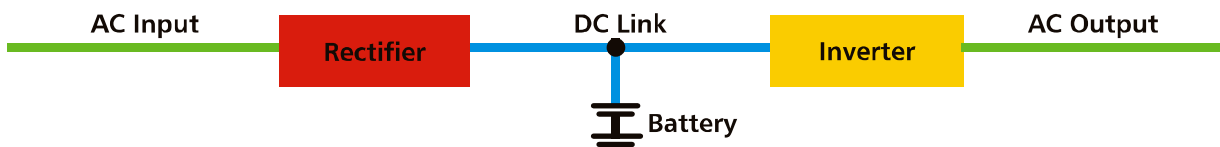

The HP FS 33 inverter complies with the IEC-62040-3 standard, having its ability to take its input power from either the AC input (via the rectifier) or the battery and supply power to the load. The rectifier is software controlled to recharge the battery and maintain it in a charged condition. The battery is galvanically connected between the rectifier output and the inverter input on a common DC link (see diagram above).

### HP FS 33 range: 10-50 kVA and 60-100 kVA

The HP FS 33 UPS, are available in scalable 19 " rack in two configurations :

- 50 kVA (5 nos modules), with a height of 36U
- 100 kVA (10 nos modules), with a height of 42U

### Applications

• Local Area Networks	• Servers	• Data centers	• Industrial PLCs	• Emergency Devices (lights/alarms)
• Cash registers	• Telecom facilities	• Industrial Processes	• e-Business	

## Parallel HP FS 33 Systems

Connecting two or more HP FS 33 units in a parallel configuration provides increased reliability and greater output power capacity. HP FS 33 units equipped with the optional parallel kit, share the load evenly and make it more dependable. Parallel HP FS 33 units can be configured with decentralized static switches or a centralized static switch. Either arrangement ensures zero downtime even during maintenance.



## UPS Monitoring System

The SNMP agent is an optional, internal card which lets you monitor and control the HP FS 33 from a PC. The SNMP agent supports standard UPS RFC1628 MIB. The SNMP agent enables monitoring, management, control and orderly shutdown of the UPS via the Internet protocol SNMP. The SNMP agent is a dedicated adapter that provides connectivity between the UPS and a management platform.



## Other Monitoring options

- Wireless Control
- Web Monitoring



## Benefits

Description	Conventional UPS	HP FS 33 Series	Benefits
Extra High Efficiency	92% average	<b>A Proven AC/AC efficiency of 96%</b> <ul style="list-style-type: none"> <li>• Cuts losses in half-from 8% to 4%</li> <li>• Reduces heat dissipation</li> </ul>	<b>SAVE ON ENERGY COSTS:</b> <ul style="list-style-type: none"> <li>• Up to Rs.1.68 L per 100kVA (80kW) a year, less running costs</li> <li>• Substantially less cooling costs</li> </ul>
N+1 Redundancy	High cost redundancy options	<b>N+1 – the most economical redundancy you can get,</b> Without over-sizing your system	<b>SAVE ON PRICE OF PURCHASE:</b> <b>Buy only what you really need</b> <ul style="list-style-type: none"> <li>• Get a minimum size &amp; minimum cost modular system solution</li> <li>• Keep your critical applications protected at all times</li> </ul>
Extra High Power Density	Only 200-400 VA/Kg 1.3-4 VA/inch <sup>3</sup> In average	<b>An astounding density of-</b> <b>1100VA/Kg 8.5VA/inch<sup>3</sup></b>	<b>SAVE ON FLOOR SPACE:</b> <ul style="list-style-type: none"> <li>• Light weight and compact footprint</li> </ul>
Green & Clean Power	THDi>5%, P.F<0.8-0.96 UPS to generator power ratio of 2-3	Unity P.F, THDi < 4-5% <b>UPS to generator power ratio of only 1:1.2</b>	<b>SAVE ON INSTALLATION:</b> <ul style="list-style-type: none"> <li>• No need for additional input filters or 12 pulse solutions</li> <li>• Reduced infrastructure costs</li> <li>• Smaller generator</li> </ul>
Customer Friendly Serviceability	Average MTTR of 30 min., and requires qualified engineer	<b>Average MTTR is less than 5 minutes,</b> with hot swap modules	<b>SAVE ON MAINTANENCE:</b> <ul style="list-style-type: none"> <li>• Lower down time</li> <li>• Reduced maintenance costs</li> </ul>
Superior Topology	<ul style="list-style-type: none"> <li>• Line Interactive</li> <li>• On-Line with standby battery</li> <li>• Delta conversion</li> <li>• "Economy" mode</li> </ul>	True On-line double conversion <b>Full compliance with IEC-62040-3</b>	<b>Reliability &amp; Scalability at low cost</b>

## Technical Specifications

Topology	True On-Line Double Conversion VFI									
Construction	Modular Parallel Hot-Plug Modules, Continuous Operation									
<b>Input</b>										
Voltage	3 x 380/400/415 V+N (Settable)									
Voltage Range	-27% - +20%									
Frequency	47-63Hz									
Power Factor	0.99									
THDi	4 - 5%									
<b>Output</b>										
Rated Power	10 kVA / 8 kW to 100 kVA / 80 kW									
Frequency	50/60Hz $\pm$ 0.1%									
Voltage	380/400/415 V+N ( Adjustable )									
Static Regulation	$\pm$ 1%									
Dynamic Response to 100% Load Step	$\pm$ 2%, <1ms Recovery Time									
Waveform	Sinusoidal									
THDu	< 2%									
Load CF (max)	6:1									
AC-AC Efficiency (nominal)	Up to 96%									
DC-AC Efficiency (nominal)	Up to 98%									
<b>General</b>										
Ambient Temperature	-10° C to +40° C ( Operating ); -20° C to 60° C ( Storage )									
Relative Humidity	95% Max Non-Condensing									
Altitude	1500m w/o De-Rating									
Enclosure Cooling	IP20									
<b>Standards</b>										
EMC Emission	EN50091-2 Class A; IEC 62040-2									
EMC Immunity	EN50082-2									
Safety	EN50091-1; IEC 62040-1-1									
Design	EN50091-3; IEC 62040-1-3									
Low Magnetic Field Radiation	EMF as Per ICNIRP									
<b>Dimensions</b>										
UPS Rating	10kVA	20kVA	30kVA	40kVA	50kVA	60kVA	70kVA	80kVA	90kVA	100kVA
Dimensions (mm) H X W X D	1800						2080			
W (mm)	600									
D (mm)	800									
Weight (kg)	173	193	208	223	238	283	298	313	328	343
<b>Acoustic Noise (@1.5m from front of unit)</b>										
Noise (dBA) Full Load	51	54	55	57	58	58.8	59.4	60	60.5	61

As standards, specifications and designs change from time to time, please ask for confirmation of the information given in this publication.

NUMERIC HOUSE No.5 , Sir P.S.Sivasamy Salai, Mylapore, Chennai - 600 004, INDIA .  
Tel : +91 -44-2499 3266 Fax : +91 -44-24998210 E-mail : info@numericups.com



A Group brand | Legrand

**REGIONAL OFFICE: AHMEDABAD** 079 - 27488779 / 556 **BANGALORE** 080 - 43038000, 01 / 02 / 03 / 04 **BHOPAL** 0755 - 2764201, 2764202  
**CHENNAI** 044 - 24982502, 24982511, 24990466, 24990064, 24993266 **COCHIN** 0484 - 2324616, 2322334 **COIMBATORE** 0422 - 2242290, 2243716, 2243740 **HYDERABAD** 040-27603048, 27662817 **KOLKATA** 033 -24609233, 24609234, 24609032 **LUCKNOW** 0522 - 2206110, 2206112 **MADURAI** 0452-2604555, 2602629 **MUMBAI** 022-28373953/54/55 **NEW DELHI** 011-25571347/48/49



Toll Free No. 1800 425 3266  
www.numericups.com  
NPDM/MKT/BRO/3PH/01

Please Refer our website : [www.numericups.com](http://www.numericups.com) for list of our service centers.



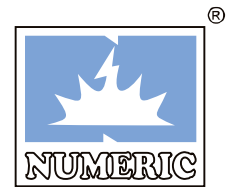

The ultimate in clean power

A Group brand | 

# NUMERIC<sup>®</sup>

## *HPE 33 Series*

10 kVA to 80 kVA



## High Performance Power Protection Solutions

### Features

- Advanced DSP controlled SPWM technology
- True Galvanic Isolation Transformer design
- ECO Mode and EPO function as standard
- Intelligent Fan Speed Control System
- Redundant power supply with dual input
- DC Cold Start Feature as standard

NUMERIC - No .1 UPS Manufacturer in India\*

(\*Source: Softdisk)



# HPE 33 Series

## 10 - 80 KVA – On-line Double Conversion Three Phase UPS Systems

**NUMERIC, India's No:1 Online UPS Manufacturer brings you the new HPE 33 Series, 3 Phase UPS Systems, which sets new level of standards in protection for your mission critical applications. HPE 33 Series ensures that all the needs of the customers are addressed efficiently and effectively.**

### True Online Double Conversion

HPE 33 Series is a true online double conversion 3/3 UPS System with VFI-SS-111 (Voltage and Frequency Independent) and state of the art Digital Signal Processor (DSP) control, solution that is best suitable for Mission Critical Application.

- Online Mode
- Eco Mode
- Intelligent Eco Mode

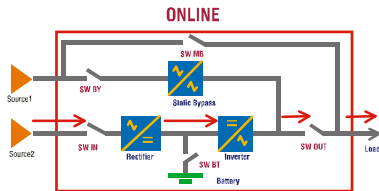

### Advanced DSP Based SPWM Technology

HPE 33 UPS System is designed with Double DSP control system, which helps in faster processing speed and simplify the circuit for better protection. This enables regulation and rapid modification of pulse width thereby maintaining the IGBT in inverter output within tolerance limits even for non-linear loads.

### Reduced Cost of Ownership

- Wide input voltage helps in minimising transfer to battery mode, thereby reducing the charge, discharge cycle and prolonging the battery life.
- Its Automatic float and boost charge control, temperature compensated battery charging and battery discharge protection helps to extend battery life.

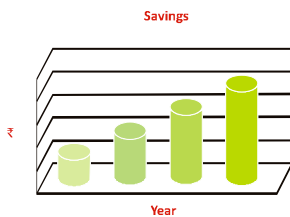

### Full function LCD display

The system incorporates a full function with Mimic diagram which is user friendly.

- Real time observation of operation parameters
- Records 1000 log events

- Battery Circuit Abnormal
- Activation of EPO & Maintenance bypass ON alarm
- Short circuit at output & Fan failure alarm
- Mimic LED panel shows the operation sequence of the UPS System

### Galvanic Isolation

HPE 33 model has an built-in Isolation transformer that provides complete Galvanic Isolation to the loads from the mains interference (Voltage & frequency variations etc...)

Designed to provide excellent output voltage stability ideally suited for demanding applications with either 100% step or unbalanced loads.

Option for Isolated output is a feature, which completely isolate the Input and Output Neutral. Advantage of isolated output will help in voltage conversion under same frequency (400V to 208V), avoids risk of UPS load on bypass mode and high N-E voltage during lightning.

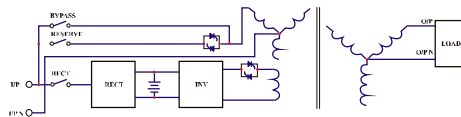

### Battery Care System

The "Battery Care System" is a set of functions designed to control, manage and preserve the battery for as long as possible.

i) Battery recharging: This UPS product will work with sealed lead acid (VRLA), AGM, open vase or Ni-Cd batteries. Depending on the type of battery, two recharging methods are available:

- Cyclical recharging
- Float and boost recharging

ii) Battery test: In normal operating conditions the battery is checked automatically at regular intervals or on manual command. The test takes place without appreciably discharging the battery, in complete safety for the load and without compromising the battery service life. If the test has a negative outcome, a report signal will appear on the UPS panel.



### Standard features for Battery Monitoring

- Battery reverse polarity connection alarm
- Temperature compensated battery charging
- Reminder for battery replacement when life is expired
- Auto start when mains return
- Automatic periodic battery maintenance function
- Automatic battery charge current set
- Remaining backup time display

### Flexibility and East to Upgrade

- Power requirements can be changed over time. HPE 33 UPS can be connected for parallel operations. Redundancy also can be added or upgraded as needed.
- UPS system can be switched ON without utility power (Cold start facility).

- Adjustable power-walk in. When UPS connected in Parallel, rectifier is turned on in sequence to avoid sudden load on the generator.

- Truly a fault tolerant design incorporating redundancy for critical circuits, Intelligent fan speed control system for better air ventilation.

- Regenerative Protective System (Optional) UPS can be fitted with regenerative protective system as external feature upto 30kVA and built-in from 40 to 80kVA. Reverse energy generated by motor, machine tools, etc. in production line is absorbed by the protective system.

### Power Options

- 12 Pulse rectifier
- LC & active filters for reducing the THDi and improving PF
- Increased IP Protection
- Cable Entry panel
- Wrap around panel for easy maintenance

## Major Applications

- Information Technology
- Work stations
- Software Development Technology
- Networking (Routers, Hubs, Switches etc)
- Bank Insurance and Financial Services
- Telecommunications, Paging and Mobile Services
- Industry and Process automation
- Transport Automation, Airport, Railway and other ticket booking centers
- Hospitality, Educational Institutions
- Building Automation

## Communication Options

- Communication alternatives through RS232 & RS485 ports
- SNMP
- Remote alarm panel
- Dry contacts for additional monitoring for the following:
  - a) UPS Fault
  - b) Battery Low Voltage
  - c) Manual Maintenance Operation
  - d) Inverter Overload
  - e) Mains Fault,
  - f) System on bypass
  - g) Abnormal output signal of the fan
  - h) Remote EPO
  - i) Battery Cabinet Switch Trip OFF
  - j) Battery Cabinet Temperature Sensor
  - k) Battery cabinet breaker detection and
  - l) ON / OFF contact

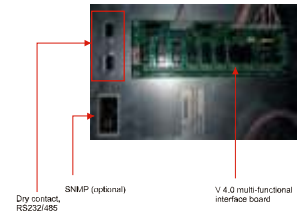

## TECHNICAL SPECIFICATIONS

Capacity (KVA)	10	20	30	40	50	60	80
----------------	----	----	----	----	----	----	----

Description	True On-line Double Conversion (VFI - SS - III)						
-------------	---	--	--	--	--	--	--

### Input

Voltage	380/ 400/ 415, 3 Ph 4 Wire						
Range	± 20%						
Frequency	50/ 60 Hz (± 5%)						
Current distortions (THDi)	< 5 - 10 % with Optional filter						
Power Factor	upto 0.96 with Optional filter						

### By Pass System Input

Voltage	380/ 400/ 415 (± 15%)						
Frequency	50/ 60 Hz ± 5%(± 10% selection)						

### Output

Voltage	380/400/415 (±1%)						
Frequency	50/ 60 ± 0.05						
Voltage (THDU)	< 3% Ph/Ph						
Dynamic Response	±/- 5%						
Overload	125% : 15 min ; 150% : 1 min						
Efficiency	Up to 92%						
Cold Start	Available						

### Environment

Noise (dBA)	< 65					< 70	
Operation temperature	0 - 40 °C						
Storage temperature	-20 - +60 °C						
Relative humidity	0 ~ 95%						

### Standards

Safety	IEC 62040-1-2						
EMC	IEC 62040-2						
Design	IEC 62040-3						
Protected grade	IP20						

### Dimensions

Depth (mm)	800						
Width x Height (mm)	500 x 1180			800 x 1600			1000 x 1800
Weight (Kg without battery)	205	240	255	430	450	470	600

As standards, specifications and designs change from time to time, please ask for confirmation of the information given in this publication.

Support: Wide Sales & After Sales Support Network with -

- 12 Regional offices • Over 258 service centres across India • Over 900 field support team • 24 x 7 x 365 Help Desk



NUMERIC HOUSE No.5 , Sir P.S.Sivasamy Salai, Mylapore, Chennai - 600 004, INDIA .  
Tel : +91 -44-2499 3266 Fax : +91 -44-24998210 E-mail : info@numericups.com



A Group brand | **legrand**

**REGIONAL OFFICE: AHMEDABAD** 079 - 27488779 / 556 **BANGALORE** 080 - 43038000, 01 / 02 / 03 / 04 **BHOPAL** 0755 - 2764201, 2764202  
**CHENNAI** 044 - 24982502, 24982511, 24990466, 24990064, 24993266 **COCHIN** 0484 - 2324616, 2322334 **COIMBATORE** 0422 - 2242290, 2243716, 2243740 **HYDERABAD** 040-27603048, 27662817 **KOLKATA** 033 -24609233, 24609234, 24609032 **LUCKNOW** 0522 - 2206110, 2206112 **MADURAI** 0452-2604555, 2602629 **MUMBAI** 022-28373953/54/55 **NEW DELHI** 011-25571347/48/49



ISO 9001 : 2008  
ISO 14001 : 2004  
BS OHSAS 18001 : 2007



No.1 Power Electronics Company  
No.1 Online UPS Manufacturer  
No.1 Line Interactive UPS Manufacturer  
\*Source : SoBokk



Toll Free No. 1800 425 3266  
www.numericups.com  
NPDM/MKT/BRO/3PH/04

NUMERIC 1/2013

Please Refer our website : [www.numericups.com](http://www.numericups.com) for list of our service centers.

# NUMERIC<sup>®</sup>

*HPE i 33 Series*

10 kVA to 120 kVA

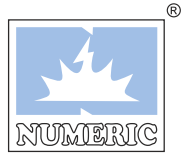

The ultimate in clean power

A Group brand | **legrand**



## High Performance Power Protection UPS Systems

### Features

- Flexible and adaptable
- IGBT Rectifier
- High Efficiency up to 94 % for On - Line mode and up to 98 % for Eco Mode
- Compact footprint
- Intuitive monitoring
- High availability architectures
- Online / Frequency Converter / Eco and Intelligent Eco modes of operations
- Designed Load PF 0.9

**NUMERIC - No. 1 UPS Manufacturer in India\***

(\*Source: Softdisk)



## HPE i 33 10-120 kVA

NUMERIC HPE i 33 10-120 kVA UPS is a true on-line 3/ 3 UPS System with VFI-SS-111 (Voltage and Frequency Independent) classification in compliance with IEC EN 62040-3 Standards that provides the user with clean power for continuous operation of critical load, regardless of any disturbance on the upstream AC power.



## Main Features

NUMERIC **HPE i 33 10-120 kVA** is suitable for use in a broad spectrum of applications, thanks to variety of configuration, accessories and options providing flexibility and choice of performance levels:

- Input current distortion < 3%
- Input power factor 0.99
- Power walk-in function to guarantee a progressive rectifier start-up.
- Load Power Factor 0.9 and suitable for powering capacitive loads, such as blade servers, without any reduction in active power (0.9 lead to 0.8 lag).
- Configurable Power Share connections to ensure backup for the most critical loads or programmed to operate only when mains power fails.
- Cold Start facility that starts the UPS even when it is not connected to the mains.

## Operational modes

These systems can be set to operate in four operating modes: ONLINE/FREQUENCY CONVERTER/ECO and ECO MODES.

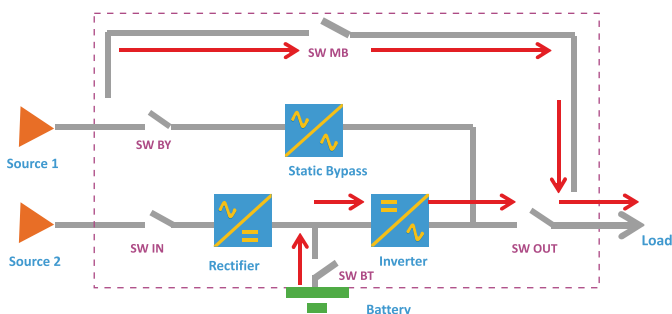

## High Efficiency

High Operating efficiency up to 94% providing energy savings with constant efficiency from 25 to 100% load.

### Efficiency (%)

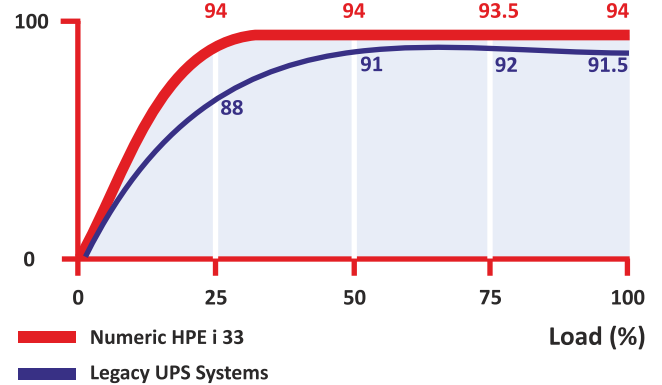

## Savings

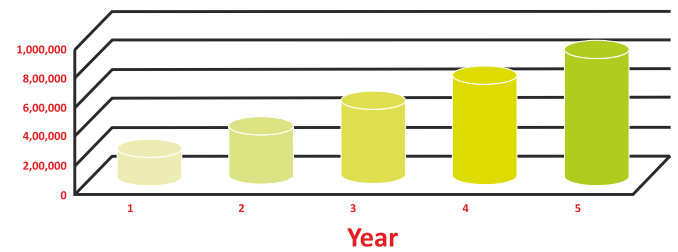

Using **HPE i 33 10-120 kVA** UPS Systems, there is a considerable savings as compared to the legacy UPS systems with a lower efficiency, not including costs saved on lower cooling requirements which is typically shown above over a 5 year period.

## Battery Care System

The **HPE i 33** Battery Care System consists of a number of functions that together Guarantee optimum battery performance such as the Intelligent charge and Limited discharge.

### Algorithm of « intelligent » charge

Automatic adjustment of charging method

Floating

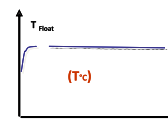

No regime in permanent floating

Alternation Floating/ Charge " pulsed"

Pulsed Charge

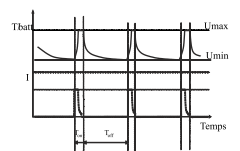

Advantage: Increases the battery life upto 50% and protects the investment on battery

### Limited Discharge

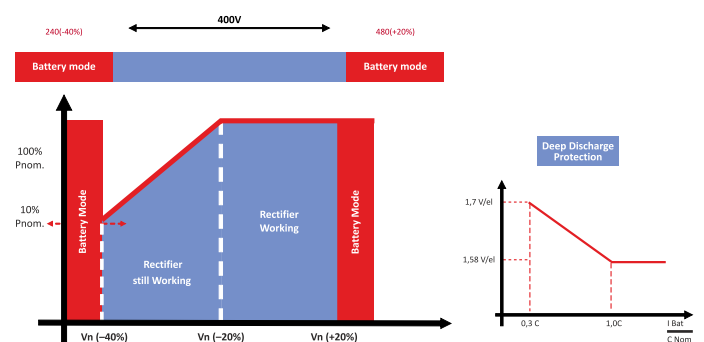

## Power Availability

**HPE  $\approx$  33 10-120kVA** are offered with output power factor of 0.9 providing up to 15 % more active power (kW) than a traditional UPS and more load expansion.

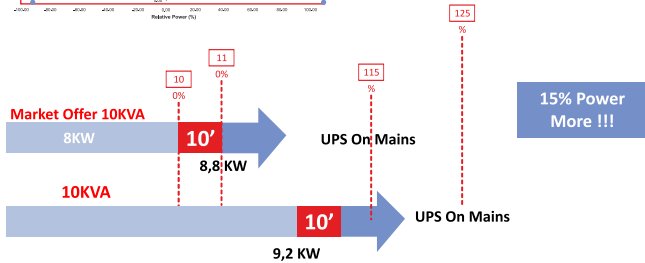
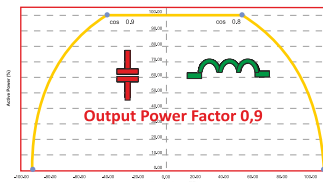

## Designed to Support New IT Loads

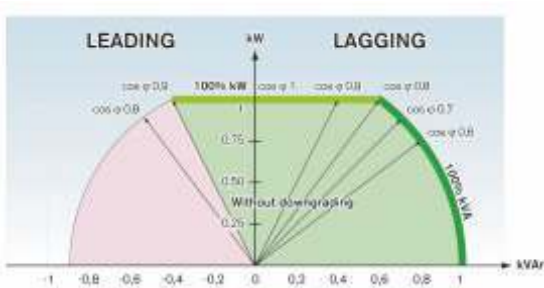

The **HPE  $\approx$  33 10-120kVA** range of UPS systems with Stable output voltage and Active power without de-rating, with loads with a lagging power factor and up to 0.9 leading. A high short-circuit capacity, up to 4 In, which facilitates the selection of protective devices for selectivity in the downstream distribution. Precise voltage even when the load between phases is completely unbalanced.

## Flexibility and Easy to upgrade

Power requirements can change over time. **HPE  $\approx$  33** Outputs can be multiplied with the " Hot System Expansion" feature, which means that a new UPS can be added to the system while the integrated UPS will configure itself automatically with the system data without any disturbances to the load.

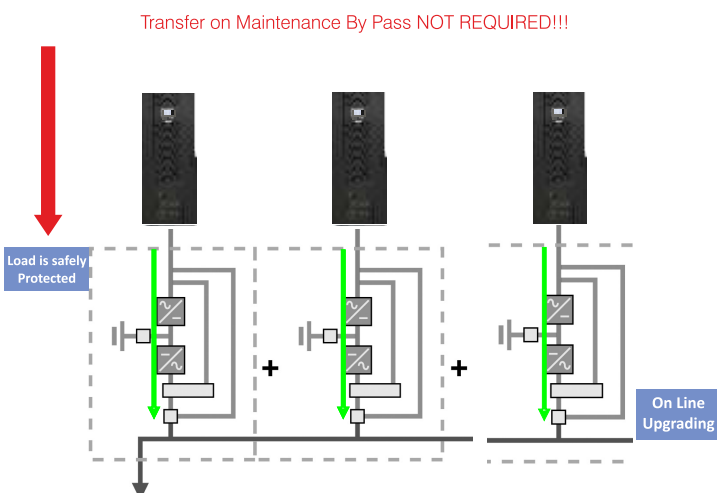

## Communication Options

**HPE  $\approx$  33** is equipped with a graphic display that provides information, measures, status and alarms regarding the UPS Systems.

Advanced, multi-platform communication for all operating systems and network environments: PowerShield3 monitoring and shut-down software included, for Windows 2008, Vista, 2003, XP; Mac OS X, Linux, Novell and most popular Unix operating systems. Compatible with the Net monitoring system.

2 slots for the installation of optional communication accessories such as network adapters and volt-free contacts.

REPO (Remote Emergency Power Off) with which to power down the UPS through a remote emergency push button.

Input for connection of the auxiliary contact of an external manual bypass.

Input for synchronization from an external source.

Graphic mimic panel display for remote connection.

SNMP compatible & RS485 JBUS /MODBUS Communication.

## Man machine interface

Large Communication Mimic panel and flexible man machine interface.



## Support:

Wide Sales & After Sales Support Network with:

- 13 Regional Offices
- Over 258 Service Centres across India
- Over 900 Field Support Team
- 24 x 7 x 365 Help Desk



## Technical Specifications

<b>Power</b>									
kVA	10	15	20	30	40	60	80	100	120
KW	9	13.5	18	27	36	54	72	90	108
Topology	True On-line Double Conversion (VFI-SS-III)								
<b>Input (AC Supply)</b>									
Rectifier type	IGBT based PF controlled rectifier								
Voltage	380 / 400 / 415 V TP + N (selectable)								
Voltage range	320 - 480V at 100% load								
	240 - 480V at 50% load								
Frequency	50 / 60Hz ± 10%								
Input power factor	> 0.99								
THDi	< 3%								
Power Walk-in	Programmable from 5 - 30 sec								
Bypass Frequency Tolerance	± 5% (adjustable from 0.25 to 10%)								
<b>Output</b>									
Voltage									
Static Regulation	± 1%								
Dynamic Regulation	± 3%								
Frequency	50 / 60 Hz								
Frequency Range	0.25 to 10% adjustable								
THDu	< 1% for 100% linear load								
	< 3% for 100% non - linear load								
Crest Factor	3:1								
Overload @ 0.8 P. F.	115% for Continuous, 125% for 10min								
	150% for 60 seconds								
	168% for 5 seconds								
<b>Overall Efficiency</b>									
On-line Double Conversion Mode	upto 94.0%					upto 93.5%			
Eco Mode	> 98%								
<b>General</b>									
Storage temperature	- 25° up to +55 °C (UPS)								
Ambient temperature	0 to 40°C								
Relative Humidity	95% Max non-condensing)								
Operating Altitude	1000m without de-rating								
Colour	RAL 7016								
Noise Level at 1 meter	48 - 52 dBA					<58dBA		<70dBA	
<b>Paralleling</b>									
Modular	Upto 6 Units								
<b>Standards</b>									
Safety	IEC 62040-1-2								
EMC	IEC 62040-2								
Design	IEC 62040-3								
Enclosure Protection	IP 20 (others on request)								
Marking	CE								
<b>Communication Options</b>	RS 232 ports for remote contacts								
	Slots for Communication Interface for SNMP & BMS integration								
<b>Dimensions</b>									
Width x Depth x Height (in mm)	440 x 850 x 1320					500 x 850 x 1600		750 x 815 x 1900	
Weight ( kgs ) with Transformer Option	175	195	215	260	315				
Weight ( kgs )	90	95	100	130	135	190	200	220	380

Note: As standards, specifications and design change from time to time, please ask for confirmation of the information given in this publication.

NUMERIC HOUSE No.5 , Sir P.S.Sivasamy Salai, Mylapore, Chennai - 600 004, INDIA .  
Tel : +91 -44-2499 3266 Fax : +91 -44-24998210 E-mail : info@numericups.com



A Group brand | **legrand**

Toll Free No. 1800 425 3266  
www.numericups.com

NUMERIC 1/2013



**REGIONAL OFFICE: AHMEDABAD** 079 - 27488779 / 556 **BANGALORE** 080 - 43038000, 01 / 02 / 03 / 04 **BHOPAL** 0755 - 2764201, 2764202  
**CHENNAI** 044 - 24982502, 24982511, 24990466, 24990064, 24993266 **COCHIN** 0484 - 2324616, 2322334 **COIMBATORE** 0422 - 2242290,  
2243716, 2243740 **HYDERABAD** 040-27603048, 27662817 **KOLKATA** 033 -24609233, 24609234, 24609032 **LUCKNOW** 0522 - 2206110,  
2206112 **MADURAI** 0452-2604555, 2602629 **MUMBAI** 022-28373953/54/55 **NEW DELHI** 011-25571347/48/49

Please Refer our website : [www.numericups.com](http://www.numericups.com) for list of our service centers.



# NUMERIC<sup>®</sup>

*HPE i 33 Series*

100 kVA to 500 kVA

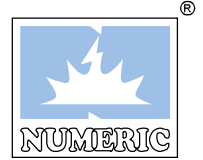

The ultimate in clean power

A Group brand | **legrand**



## High Performance Power Quality Solutions for Mission Critical Applications

### Features

- True online double conversion UPS Systems
- High Efficiency
- Advanced IGBT Rectifier
- Compact footprint
- In-built Galvanic Isolation transformer
- Parallel System Joiner
- Online, Eco, Intelligent Eco modes of operations
- Energy saving feature as standard



**NUMERIC - No .1 UPS Manufacturer in India\***

(\*Source: Softdisk)

## HPE i33 : Critical Power Protection up to 3200 kVA

The new range of HPE i 33 series from Numeric is ideal for today's advanced digital computing, communications, process control and medical systems.

The UPS Systems are designed with a True On-Line Double Conversion topology, and the state of the art Digital Signal Processor (DSP) control. It is especially suited for mission critical applications being classified as VFI SS 111 (Voltage and Frequency Independent) in compliance with IEC EN 62040-3 standards.

The Digital HPE i 33 series guarantees maximum protection as well as high quality power for any type of IT and

industrial load. This series has been designed using a new configuration that includes an IGBT rectifier with Sinusoidal input current in place of the traditional Thyristor Rectifier.

The UPS capacity ranges from 100 to 500 kVA.



### Main Features & Applications



- IGBT Rectifier.
- 0.99 Input Power Factor
- THDi: <3%
- Efficiency up to 94% for On-line mode and upto 98% for Eco Mode.
- Compact footprint : 0.85 m<sup>2</sup> for the 500 kVA UPS Model.
- Galvanic protection of the load from the mains.

The HPE i 33 range is suitable for a wide range of applications, thanks to the flexibility of the configurations, accessories, options and choice of performance levels. These systems are compatible with capacitive loads, such as blade servers, without any reduction in active power, ranging from 0.9 lead to

0.8 lag. It is an efficient and reliable power supply for mission critical applications by operating in redundant Configurations such as the Power Parallel Mode (N+1), Dual Bus System and Dynamic Dual Bus system configurations.

#### Active Power Factor Correction :

The input current is maintained sinusoidal with power factor > 0.99 and low current harmonics distortion of <3%

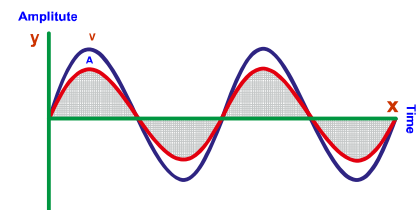

### Cost effective equipment

- A compact unit.
- Simplified maintenance.
- An advanced diagnostic system
- A remote access device connected to the remote maintenance centre.
- An IGBT rectifier, which reduces the size of the infrastructure (transformer, generator set and distribution).

- Easy access to subassemblies and components, facilitating tests and reducing maintenance time (MTTR), includes a built-in maintenance bypass, optional wrap-around maintenance bypass with IP 20 protection

### Easy to install

- Small footprint.
- No need for rear or side access. All connections are made through the front.
- All switches requiring connection can be accessed from the front
- Ready for all system earthing arrangement.

## Operational modes:

These systems can be set to operate in four operating modes: ON-LINE, STAND-BY ON, INTELLIGENT ECO MODE and STAND-BY OFF.

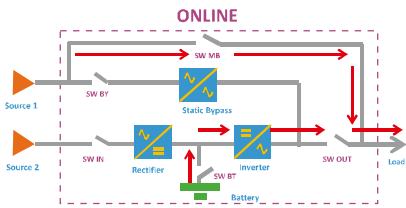

### Mode: ON-LINE Normal Operation:

The rectifier draws energy from the mains to power the inverter and charge the battery; the inverter powers the load with voltage and frequency stabilized and in synchronization with the by-pass. When the mains power supply goes out of the pre-set limits,

the rectifier switches off and the inverter is powered from the battery for the envisaged back-up time without any disturbance to the load.

**Mode: STAND-BY ON** The load is normally powered from the by-pass mains, and the rectifier keeps the batteries charged. When the mains voltage is outside the preset range, the load is transferred automatically to the inverter until the mains returns to the preset range. This mode is suitable for powering loads that are not sensitive to mains interference, thus allowing increased efficiency of upto 98%.

### Mode : INTELLIGENT ECO MODE

When the HPEi 33 is configured in Intelligent Eco Mode, it automatically defines whether to operate in ON-LINE

or STAND-BY OFF mode. This is done by monitoring the by-pass mains if this remains suitable for a defined period, the system sets itself to STAND-BY ON mode; otherwise it remains in ON-LINE mode.

**Mode : STAND-BY OFF** When the mains power supply is present, the rectifier keeps the batteries charged and the inverter is switched off. When the mains fails, the rectifier switches off and the inverter is activated in approx. 200 ms, using the battery energy. This application is suitable for the power supply of emergency lighting, as defined by standard EN 50171.

## Zero Impact on source

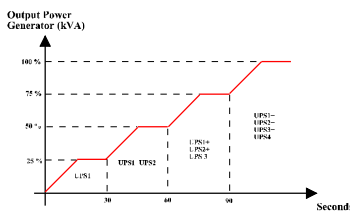

The HPE i 33 series with the added advantages offered by an IGBT-based rectifier assembly reduces the impact of the UPS on the local supply and simplifies installation where there is limited power capacity in the form of available electrical supply rating or generator size:

- Low input current distortion – less than 3%
- High input power factor 0.99
- Power walk-in function that ensures progressive rectifier start up

Delayed start up phased with the return of mains power supply as shown in the figure, when several UPS are connected in the system.



## Battery Care System

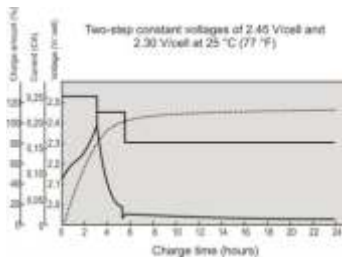

The “Battery Care System” is a set of functions to control, manage and preserve the battery as long as possible.

**a) Battery Recharging:** This UPS is suitable for hermetic sealed lead acid batteries (VRLA), AGM, and Ni-Cd. Depending on the battery type, two recharge methods are available:

- **Cyclical recharging (factory set):** The state of the battery charge is kept constantly under control and when the charge level drops below the established level, a recharge cycle starts up automatically.
- **Two level recharging (configurable):** This recharge is carried out with two levels of current at two voltage levels

following the U1 U2 characteristic (EN 50272-2).

**b) Battery test:** In normal operating conditions, the battery is checked automatically at regular intervals or on manual command.

**c) Protection against slow discharge:** In the event of discharges of long duration and low load, the end of discharge voltage is raised to approx. 1.8 V/cell as prescribed by the battery manufacturers so as to avoid damaging the batteries.

## Designed to Support New IT Loads

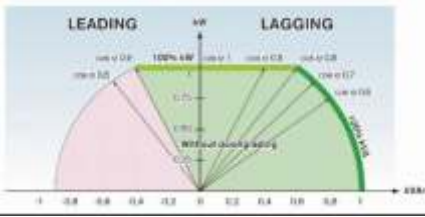

- The HPE i 33 range of UPS systems fitted with a transformer integrated downstream of the

inverter allows supply to your installations with:

- Stable output voltage during significant and quick variations in loads ( $\pm 2\%$  in less than 5 ms).
- Sinusoidal THDU output voltage  $< 1\%$  with linear loads and  $< 3\%$  with non-linear loads.
- Active power without de-rating on loads from 0.8 lagging power factor to 0.9 leading power factor.

- A high short-circuit capacity, upto 4 In, which facilitates the selection of protective devices for selectivity in the downstream distribution.
- Precise voltage even when the load between phases is completely unbalanced.
- Galvanic isolation between the DC bus and load to ensure complete protection of load from UPS Upstream neutral disturbances.

## Flexibility and Easy to upgrade

Power requirements can change over time. HPE i 33 output can be multiplied upto 8 UPS Systems in parallel. Redundancy can also be added or upgraded as needed e.g. 2N, N+1 or N+2.

the system data without any disturbance to the load.

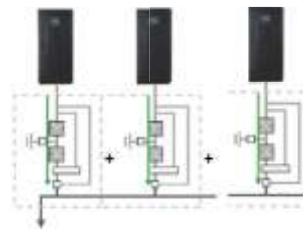

The "Hot System Expansion" feature means that a new UPS can be added to the system while the integrated UPS will configure itself automatically with

## Dynamic Dual Bus System

Two independent systems can be configured in Dual Bus with a single or separate power source. The synchronization option keeps the outputs of the two systems constantly synchronized, regardless of the input variations and when the system is powered by the battery.

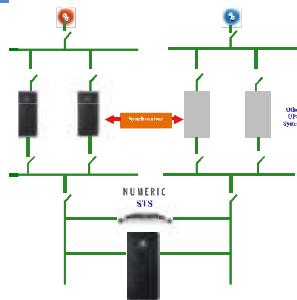

## Parallel System Joiner

Two independent systems (up to 4 units each) can be connected in a "Dynamic Dual Bus" configuration by means of the PSJ (Parallel System Joiner) option. This enables the two systems to be joined to form a single system when, for example, part of one system is undergoing maintenance and it is felt appropriate to use the redundant UPS for both bus bars of the

load. The synchronization and the equal distribution of power is guaranteed by the PSJ.

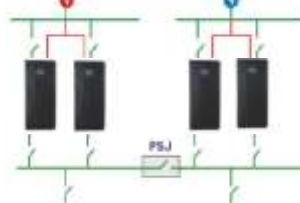

## Energy savings up to 94% efficiency

The Innovative Technology and Engineering built into the Electronics of HPE i 33 UPS Systems, for better and faster regulation, results in high

efficiency, benefiting in energy savings to cut costs and reduced air conditioning and ventilation costs.

## High Availability Configurations and Flexible architecture

High availability results not only from UPS reliability, but also from innovative and resilient architectures providing:

### On-line UPS Configuration



### Hot Standby Configuration



### Parallel UPS Configuration

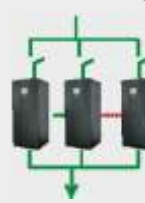

### Dual Bus Architecture

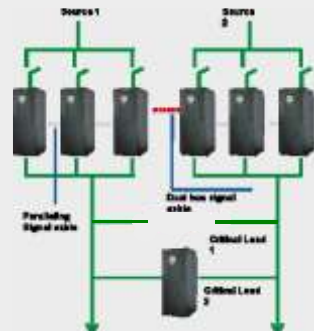

## Specifications

<b>Power</b>								
kVA	100	120	160	200	250	300	400	500
KW	90	108	144	180	225	270	360	450
Topology	True On-line Double Conversion (VFI-SS-III)							
<b>Input</b>								
Voltage	380/400/415V TP+N (settable)							
Voltage range	± 15%							
Frequency	50 / 60Hz							
Frequency range	45 - 65 Hz							
Input Power Factor	> 0.99							
THDi	< 3%							
Soft-start	0 to 100 in 30 sec (selectable)							
Bypass Frequency Tolerance	± 2% selectable between 1Hz - 5Hz							
Standard fittings	Backfeed protection							
<b>Output</b>								
Voltage	380/400/415V TP+N (settable)							
Static Regulation	± 1%							
Dynamic Response to 100% load step	± 2%, < 5 msec recovery time							
Frequency	50 / 60Hz (Selectable)							
Frequency Synchronization	0.25Hz - 3Hz Selectable							
Waveform	Sinusoidal							
THDu	< 1% for 100% linear load < 3% for 100% non-linear load							
Crest Factor	3 : 1							
Overload	110% for 60 minutes							
	125% for 10 minutes							
	150% for 60 seconds							
<b>Overall Efficiency</b>								
Eco Mode	> 98.0%							
On-line Mode	upto 94.0%							
<b>General</b>								
Ambient temperature	0 to 40° C							
Relative Humidity	95% Max non-condensing							
Altitude	1000m w/o de-rating							
Colour	RAL 7016							
Noise Level	63 - 68dBA			70 - 72dBA			75dBA	
<b>Standards</b>								
Safety	IEC 62040-1-1							
EMC	IEC 62040-2							
Enclosure Protection	IP 20 (others on request)							
Marking	CE							
<b>Communication Options</b>								
2 x RS 232 ports for remote contacts								
2 x Slots for Communication Interface for SNMP & BMS								
Other additional options available on request								
<b>Dimensions in mm</b>								
Width	800		1000			1500		2100
Depth and Height	850 / 1900					1000/1900		
Weight ( Kgs )	656	700	800	910	1000	1400	1700	2100

Note :

As standards, specifications and designs change from time to time, please ask for confirmation of the information given in this publication.

## Monitoring and control

The alarms, commands and the communication software supplied together with the UPS to interface the unit with the system are listed below.

Two DB9 connectors are available for RS232 connection; these outputs can be connected to a remote computer or to a Modem.

Two Communication slots are available at the Front of the UPS to house any two of the following communication options:

**a) Network Agent:** For the management of the UPS connected directly on the LAN 10/100Mbps using the main protocol of network communication (TCP / IP, HTTP and SNMP). A MODEM can also be connected to the same device.

**b) Modbus / Jbus protocol converter:** By means of RS232 or RS485 output for the monitoring of UPS in BMS (Building Management System). It also manages a second independent RS232 serial line that can be used to connect other devices such as a PC.

**c) Profibus Connectivity:** An accessory that makes it possible to connect the UPS to mains that uses the Profibus DP communication protocol.

**d) Contact card with programmable power relay (5A-250V)** for connecting a remote control device.

**e) Graphic remote panel** Gets UPS status remotely on a graphic panel with measurements and alarms. In addition it is fitted with a RS485 port which provides the information in JBUS/MODBUS protocol for the BMS.



### Support:

#### Wide Sales & After Sales Support Network with :

- 12 Regional offices
- Over 258 Service Centers across India
- Over 900 Field Support Team
- 24 x 7 x 365 Help Desk



NUMERIC HOUSE No.5 , Sir P.S.Sivasamy Salai, Mylapore, Chennai - 600 004, INDIA .  
Tel : +91 -44-2499 3266 Fax : +91 -44-24998210 E-mail : info@numericups.com



A Group brand | **legrand**

**REGIONAL OFFICE: AHMEDABAD** 079 - 27488779 / 556 **BANGALORE** 080 - 43038000, 01 / 02 / 03 / 04 **BHOPAL** 0755 - 2764201, 2764202  
**CHENNAI** 044 - 24982502, 24982511, 24990466, 24990064, 24993266 **COCHIN** 0484 - 2324616, 2322334 **COIMBATORE** 0422 - 2242290, 2243716, 2243740 **HYDERABAD** 040-27603048, 27662817 **KOLKATA** 033 -24609233, 24609234, 24609032 **LUCKNOW** 0522 - 2206110, 2206112 **MADURAI** 0452-2604555, 2602629 **MUMBAI** 022-28373953/54/55 **NEW DELHI** 011-25571347/48/49



Toll Free No. 1800 425 3266  
www.numericups.com  
NPDM/MKT/BRO/3PH/03

Please Refer our website : [www.numericups.com](http://www.numericups.com) for list of our service centers.

# NUMERIC<sup>®</sup>

*HPE i 33 Series*

100 kVA to 500 kVA

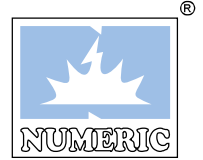

The ultimate in clean power

A Group brand | **legrand**



## High Performance Power Quality Solutions for Mission Critical Applications

### Features

- True online double conversion UPS Systems
- High Efficiency
- Advanced IGBT Rectifier
- Compact footprint
- In-built Galvanic Isolation transformer
- Parallel System Joiner
- Online, Eco, Intelligent Eco modes of operations
- Energy saving feature as standard



**NUMERIC - No .1 UPS Manufacturer in India\***

(\*Source: Softdisk)

## HPE i33 : Critical Power Protection up to 3200 kVA

The new range of HPE i 33 series from Numeric is ideal for today's advanced digital computing, communications, process control and medical systems.

The UPS Systems are designed with a True On-Line Double Conversion topology, and the state of the art Digital Signal Processor (DSP) control. It is especially suited for mission critical applications being classified as VFI SS 111 (Voltage and Frequency Independent) in compliance with IEC EN 62040-3 standards.

The Digital HPE i 33 series guarantees maximum protection as well as high quality power for any type of IT and

industrial load. This series has been designed using a new configuration that includes an IGBT rectifier with Sinusoidal input current in place of the traditional Thyristor Rectifier.

The UPS capacity ranges from 100 to 500 kVA.



### Main Features & Applications



- IGBT Rectifier.
- 0.99 Input Power Factor
- THDi : <3%
- Efficiency up to 94% for On-line mode and upto 98% for Eco Mode.
- Compact footprint : 0.85 m<sup>2</sup> for the 500 kVA UPS Model.
- Galvanic protection of the load from the mains.

The HPE i 33 range is suitable for a wide range of applications, thanks to the flexibility of the configurations, accessories, options and choice of performance levels. These systems are compatible with capacitive loads, such as blade servers, without any reduction in active power, ranging from 0.9 lead to

0.8 lag. It is an efficient and reliable power supply for mission critical applications by operating in redundant Configurations such as the Power Parallel Mode (N+1), Dual Bus System and Dynamic Dual Bus system configurations.

#### Active Power Factor Correction :

The input current is maintained sinusoidal with power factor > 0.99 and low current harmonics distortion of <3%

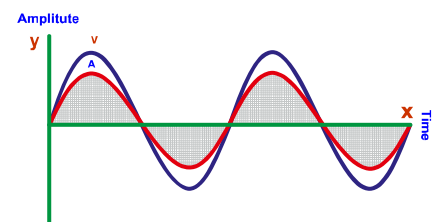

### Cost effective equipment

- A compact unit.
- Simplified maintenance.
- An advanced diagnostic system
- A remote access device connected to the remote maintenance centre.
- An IGBT rectifier, which reduces the size of the infrastructure (transformer, generator set and distribution).

- Easy access to subassemblies and components, facilitating tests and reducing maintenance time (MTTR), includes a built-in maintenance bypass, optional wrap-around maintenance bypass with IP 20 protection

### Easy to install

- Small footprint.
- No need for rear or side access. All connections are made through the front.
- All switches requiring connection can be accessed from the front
- Ready for all system earthing arrangement.



## Operational modes:

These systems can be set to operate in four operating modes: ON-LINE, STAND-BY ON, INTELLIGENT ECO MODE and STAND-BY OFF.

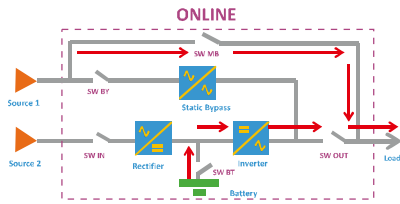

### Mode: ON-LINE Normal Operation:

The rectifier draws energy from the mains to power the inverter and charge the battery; the inverter powers the load with voltage and frequency stabilized and in synchronization with the by-pass. When the mains power supply goes out of the pre-set limits,

the rectifier switches off and the inverter is powered from the battery for the envisaged back-up time without any disturbance to the load.

**Mode: STAND-BY ON** The load is normally powered from the by-pass mains, and the rectifier keeps the batteries charged. When the mains voltage is outside the preset range, the load is transferred automatically to the inverter until the mains returns to the preset range. This mode is suitable for powering loads that are not sensitive to mains interference, thus allowing increased efficiency of upto 98%.

### Mode : INTELLIGENT ECO MODE

When the HPEi 33 is configured in Intelligent Eco Mode, it automatically defines whether to operate in ON-LINE

or STAND-BY OFF mode. This is done by monitoring the by-pass mains if this remains suitable for a defined period, the system sets itself to STAND-BY ON mode; otherwise it remains in ON-LINE mode.

**Mode : STAND-BY OFF** When the mains power supply is present, the rectifier keeps the batteries charged and the inverter is switched off. When the mains fails, the rectifier switches off and the inverter is activated in approx. 200 ms, using the battery energy. This application is suitable for the power supply of emergency lighting, as defined by standard EN 50171.

## Zero Impact on source

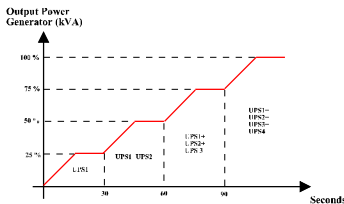

The HPE i 33 series with the added advantages offered by an IGBT-based rectifier assembly reduces the impact of the UPS on the local supply and simplifies installation where there is limited power capacity in the form of available electrical supply rating or generator size:

- Low input current distortion – less than 3%
- High input power factor 0.99
- Power walk-in function that ensures progressive rectifier start up

Delayed start up phased with the return of mains power supply as shown in the figure, when several UPS are connected in the system.



## Battery Care System

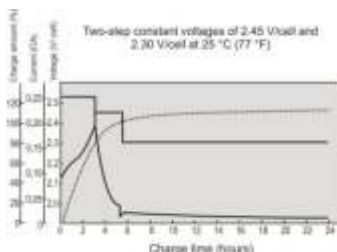

The "Battery Care System" is a set of functions to control, manage and preserve the battery as long as possible.

**a) Battery Recharging:** This UPS is suitable for hermetic sealed lead acid batteries (VRLA), AGM, and Ni-Cd. Depending on the battery type, two recharge methods are available:

- **Cyclical recharging (factory set):** The state of the battery charge is kept constantly under control and when the charge level drops below the established level, a recharge cycle starts up automatically.
- **Two level recharging (configurable):** This recharge is carried out with two levels of current at two voltage levels

following the U1 U2 characteristic (EN 50272-2).

**b) Battery test:** In normal operating conditions, the battery is checked automatically at regular intervals or on manual command.

**c) Protection against slow discharge:** In the event of discharges of long duration and low load, the end of discharge voltage is raised to approx. 1.8 V/cell as prescribed by the battery manufacturers so as to avoid damaging the batteries.

## Designed to Support New IT Loads

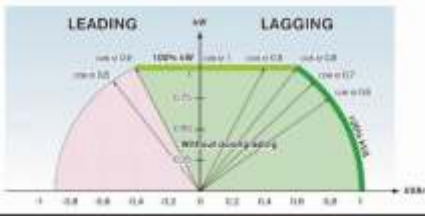

- The HPE i 33 range of UPS systems fitted with a transformer integrated downstream of the

inverter allows supply to your installations with:

- Stable output voltage during significant and quick variations in loads ( $\pm 2\%$  in less than 5 ms).
- Sinusoidal THDu output voltage  $< 1\%$  with linear loads and  $< 3\%$  with non-linear loads.
- Active power without de-rating on loads from 0.8 lagging power factor to 0.9 leading power factor.

- A high short-circuit capacity, upto 4 In, which facilitates the selection of protective devices for selectivity in the downstream distribution.
- Precise voltage even when the load between phases is completely unbalanced.
- Galvanic isolation between the DC bus and load to ensure complete protection of load from UPS Upstream neutral disturbances.

## Flexibility and Easy to upgrade

Power requirements can change over time. HPE i 33 output can be multiplied upto 8 UPS Systems in parallel. Redundancy can also be added or upgraded as needed e.g. 2N, N+1 or N+2.

the system data without any disturbance to the load.

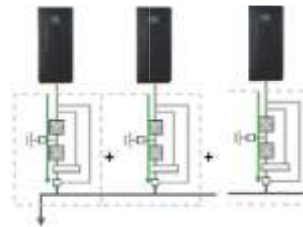

The "Hot System Expansion" feature means that a new UPS can be added to the system while the integrated UPS will configure itself automatically with

## Dynamic Dual Bus System

Two independent systems can be configured in Dual Bus with a single or separate power source. The synchronization option keeps the outputs of the two systems constantly synchronized, regardless of the input variations and when the system is powered by the battery.

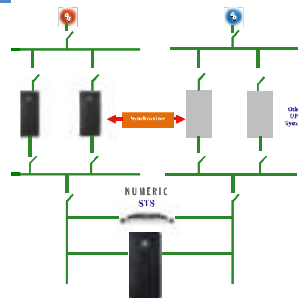

## Parallel System Joiner

Two independent systems (up to 4 units each) can be connected in a "Dynamic Dual Bus" configuration by means of the PSJ (Parallel System Joiner) option. This enables the two systems to be joined to form a single system when, for example, part of one system is undergoing maintenance and it is felt appropriate to use the redundant UPS for both bus bars of the

load. The synchronization and the equal distribution of power is guaranteed by the PSJ.

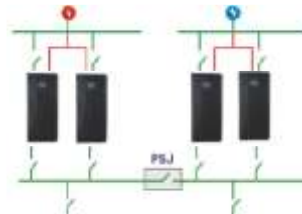

## Energy savings up to 94% efficiency

The Innovative Technology and Engineering built into the Electronics of HPE i 33 UPS Systems, for better and faster regulation, results in high

efficiency, benefiting in energy savings to cut costs and reduced air conditioning and ventilation costs.

## High Availability Configurations and Flexible architecture

High availability results not only from UPS reliability, but also from innovative and resilient architectures providing:

### On-line UPS Configuration



### Hot Standby Configuration



### Parallel UPS Configuration

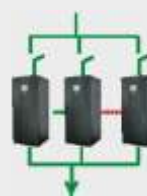

### Dual Bus Architecture

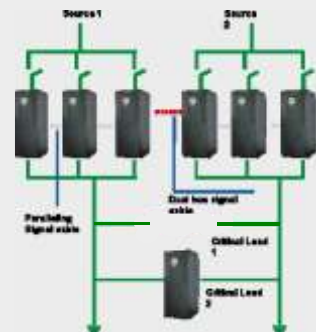

## Specifications

<b>Power</b>								
kVA	100	120	160	200	250	300	400	500
KW	90	108	144	180	225	270	360	450
Topology	True On-line Double Conversion (VFI-SS-III)							
<b>Input</b>								
Voltage	380/400/415V TP+N (settable)							
Voltage range	± 15%							
Frequency	50 / 60Hz							
Frequency range	45 - 65 Hz							
Input Power Factor	> 0.99							
THDi	< 3%							
Soft-start	0 to 100 in 30 sec (selectable)							
Bypass Frequency Tolerance	± 2% selectable between 1Hz - 5Hz							
Standard fittings	Backfeed protection							
<b>Output</b>								
Voltage	380/400/415V TP+N (settable)							
Static Regulation	± 1%							
Dynamic Response to 100% load step	± 2%, < 5 msec recovery time							
Frequency	50 / 60Hz (Selectable)							
Frequency Synchronization	0.25Hz - 3Hz Selectable							
Waveform	Sinusoidal							
THDu	< 1% for 100% linear load < 3% for 100% non-linear load							
Crest Factor	3 : 1							
Overload	110% for 60 minutes							
	125% for 10 minutes							
	150% for 60 seconds							
<b>Overall Efficiency</b>								
Eco Mode	> 98.0%							
On-line Mode	upto 94.0%							
<b>General</b>								
Ambient temperature	0 to 40° C							
Relative Humidity	95% Max non-condensing							
Altitude	1000m w/o de-rating							
Colour	RAL 7016							
Noise Level	63 - 68dBA		70 - 72dBA				75dBA	
<b>Standards</b>								
Safety	IEC 62040-1-1							
EMC	IEC 62040-2							
Enclosure Protection	IP 20 (others on request)							
Marking	CE							
<b>Communication Options</b>	2 x RS 232 ports for remote contacts							
	2 x Slots for Communication Interface for SNMP & BMS							
	Other additional options available on request							
<b>Dimensions in mm</b>								
Width	800		1000			1500		2100
Depth and Height	850 / 1900					1000/1900		
Weight ( Kgs )	656	700	800	910	1000	1400	1700	2100

Note :

As standards, specifications and designs change from time to time, please ask for confirmation of the information given in this publication.

## Monitoring and control

The alarms, commands and the communication software supplied together with the UPS to interface the unit with the system are listed below.

Two DB9 connectors are available for RS232 connection; these outputs can be connected to a remote computer or to a Modem.

Two Communication slots are available at the Front of the UPS to house any two of the following communication options:

**a) Network Agent:** For the management of the UPS connected directly on the LAN 10/100Mbps using the main protocol of network communication (TCP / IP, HTTP and SNMP). A MODEM can also be connected to the same device.

**b) Modbus / Jbus protocol converter:** By means of RS232 or RS485 output for the monitoring of UPS in BMS (Building Management System). It also manages a second independent RS232 serial line that can be used to connect other devices such as a PC.

**c) Profibus Connectivity:** An accessory that makes it possible to connect the UPS to mains that uses the Profibus DP communication protocol.

**d) Contact card with programmable power relay (5A-250V)** for connecting a remote control device.

**e) Graphic remote panel** Gets UPS status remotely on a graphic panel with measurements and alarms. In addition it is fitted with a RS485 port which provides the information in JBUS/MODBUS protocol for the BMS.



### Support:

Wide Sales & After Sales Support Network with :

- 12 Regional offices
- Over 258 Service Centers across India
- Over 900 Field Support Team
- 24 x 7 x 365 Help Desk

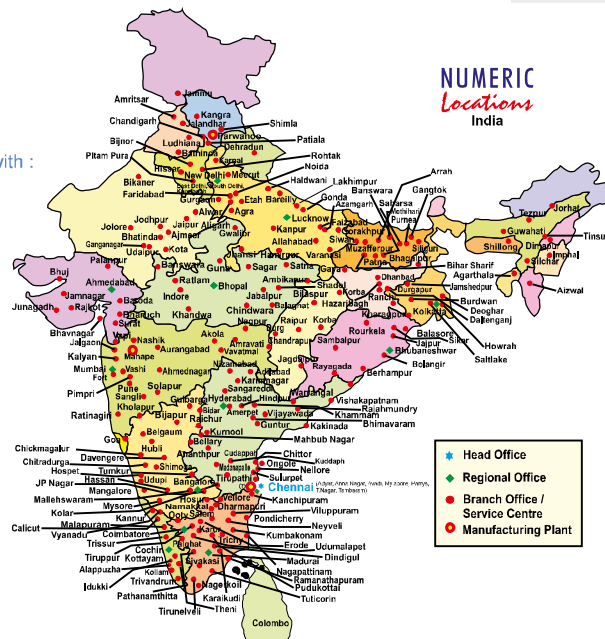

NUMERIC HOUSE No.5 , Sir P.S.Sivasamy Salai, Mylapore, Chennai - 600 004, INDIA .

Tel : +91 -44-2499 3266 Fax : +91 -44-24998210 E-mail : info@numericups.com



The ultimate in clean power

A Group brand | **legrand**

**REGIONAL OFFICE: AHMEDABAD** 079 - 27488779 / 556 **BANGALORE** 080 - 43038000, 01 / 02 / 03 / 04 **BHOPAL** 0755 - 2764201, 2764202 **CHENNAI** 044 - 24982502, 24982511, 24990466, 24990064, 24993266 **COCHIN** 0484 - 2324616, 2322334 **COIMBATORE** 0422 - 2242290, 2243716, 2243740 **HYDERABAD** 040-27603048, 27662817 **KOLKATA** 033 -24609233, 24609234, 24609032 **LUCKNOW** 0522 - 2206110, 2206112 **MADURAI** 0452-2604555, 2602629 **MUMBAI** 022-28373953/54/55 **NEW DELHI** 011-25571347/48/49



Toll Free No. 1800 425 3266  
www.numericups.com  
NPDM/MKT/BRO/3PH/03

Please Refer our website : [www.numericups.com](http://www.numericups.com) for list of our service centers.